



## **INSTALLATION & MAINTENANCE INSTRUCTIONS**

01-2016

## **SAFETY AND PROPER USAGE**

To ensure safe and enduring performance of this product, you must comply strictly with the instructions enclosed herein. Non-compliance with instructions or improper handling of the product will void your warranty! Usage of this product in conditions not specified in this manual or in contrary to the instructions hereby provided is considered IMPROPER. The manufacturer will not be held liable for any damages resulting from improper use of the product.

## **SAFETY & WARNING INSTRUCTIONS**

- Observe valid and generally accepted safety rules when planning, installing and using this product.
- Take proper measures to prevent unintentional operation of the product or damage to it.
- Do not attempt to disassemble this product or lines in the system while they are under pressure.
- Always depressurise the compressed air system before working on the system.

It is important that personnel use safe working practices and observe all regulations and legal requirements for safety when operating this product. When handling, operating or carrying out maintenance on this product, personnel must employ safe engineering practices and observe all local health & safety requirements & regulations. International users refer to regulations that prevail within the country of installation. Most accidents, which occur during the operation and maintenance of machinery, are the result of failure to observe basic safety rules or precautions. An accident can often be avoided by recognising a situation that is potentially dangerous. Improper operation or maintenance of this product could be dangerous and result in an accident causing injury or death. The manufacturer cannot anticipate every possible circumstance, which may represent a potential hazard. The WARNINGS in this manual cover the most common potential hazards and are therefore not all-inclusive. If the user employs an operating procedure, an item of equipment or a method of working which is not specifically recommended by the manufacturer he must ensure that the product will not be damaged or made unsafe and that there is no risk to persons or property.

## **GENERAL MAGNET SAFETY**

The magnets in the operator we use are extremely strong, and must be handled with care to avoid personal injury and damage to the magnets. Fingers and other body parts can get severely pinched between two attracting magnets. The strong magnetic fields of the magnets in the operator can also damage magnetic media such as floppy disks, credit cards, magnetic I.D. cards, cassette tapes, video tapes or other such devices. They can also damage televisions, VCRs, computer monitors and other CRT displays. Never place the operator near electronic appliances. Never allow magnets near a person with a pacemaker or similar medical aid. The strong magnetic fields of the magnets in the operator can affect the operation of such devices. The operator will lose its magnetic properties if heated above 175 °F (80 °C).

## **NEVER CHANGE ORIGINAL COMPONENTS WITH ALTERNATIVES**

## INSTALLATION INSTRUCTIONS

Before installing this product, make sure it complies with your request and that it suits your application!

---

1.1 Unpack the unit and visually inspect for any transport damage incurred after leaving our factory.

---

1.2 Depressurise the system before installation or maintenance is carried out!

---

1.3 The anti-airlock-adapter is a NPT or BSP pipe union with a venting tube insert.

---

1.4 The anti-airlock-adapter must always be installed at the source of condensate. The top section of the union must always be connected to the condensate source, use a 18mm wrench.

---

1.5(a) The bottom half of the drain can be adjusted to suit your application. Unscrew the four housing bolts using a 6mm Allen key if it is necessary to adjust the outlet side of the drain.

---

1.5(b) Mount the bottom half as desired.

---

1.5(c) Tighten the four housing bolts using a 6mm Allen key (max. torque 10 Nm).

- *Make sure the housing gasket is properly placed between the housing parts.*

---

1.6 Install the drain together with the venting tube insert on to the anti-airlock-adapter and align as desired. Make sure the short straw of the venting tube is facing down inside the drain and the long part of the straw is facing up.

- *Make sure the venting tube insert is in between the brass and aluminium parts.*

- *The drain must be level to ensure proper operation.*

---

1.7 Connect the outlet to an oil/water separator.

---

1.8 Slowly pressurize the system.

---

1.9 Your drain is ready for operation!

---

*Note: We advise to check this product **at least once a year** and replace serviceable parts when necessary.*

1.1



1.2

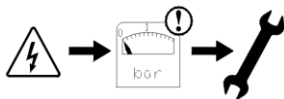

1.3



1.4



1.5(a)



1.5(b)

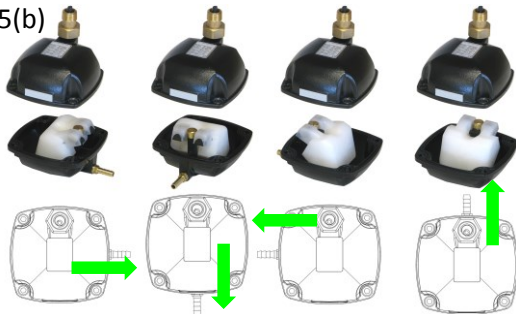

1.5(c)



1.6



1.7

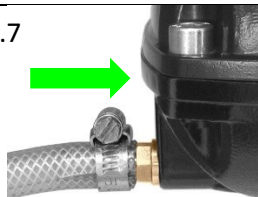

1.8



1.9



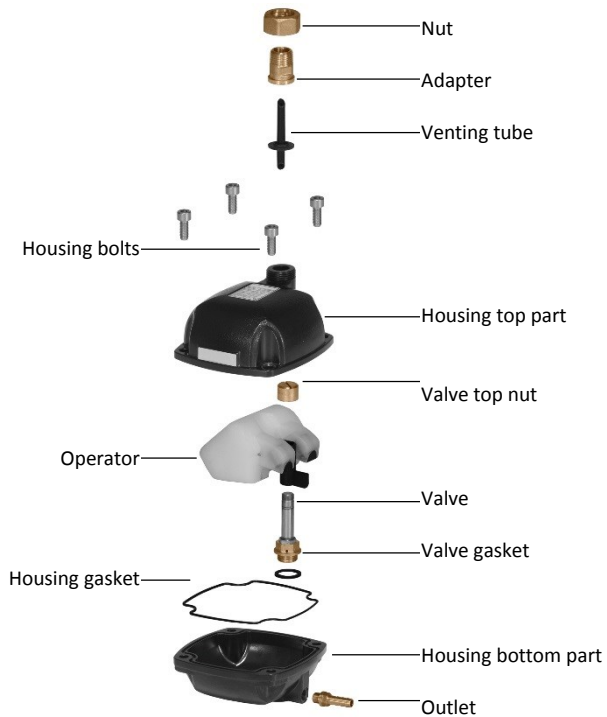

## CLEANING INSTRUCTIONS

These instructions are for cleaning the drain. If your drain requires maintenance, i.e. replacement of wearing components, please refer to our dedicated maintenance instructions (supplied with the service kit).

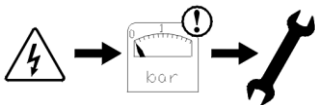

*Depressurise the system before installation or maintenance is carried out!*

---

2.1 Isolate the drain from the condensate supply, depressurize the drain housing and remove the drain from the air system.

*DO NOT ATTEMPT TO REMOVE THE DRAIN FROM THE AIR SYSTEM WHILE UNDER PRESSURE!*

---

2.2. Open the housing by unscrewing the 4 housing bolts using a 6mm Allen key and remove the top part of the housing.

---

2.4 Pull the operator assembly off the valve shaft.

*Make sure you don't damage the valve shaft.*

---

2.5 Unscrew the valve from the bottom part of the housing using a 17mm wrench.

---

2.6 Disassemble the valve using a 13 and 17mm wrench and clean all the valve parts.

---

2.7 Reassemble the valve inner parts and place the valve gasket under the valve and screw the valve assembly back in to the housing (max. torque 7Nm).

*- Make sure the valve gasket is properly placed.*

---

2.8 Replace the operator assembly. Make sure to push the operator all the way down.

---

2.9 Replace the valve top nut (max. torque 0,5Nm).

---

2.10 Replace the housing top part and tighten the 4 bolts using a 6mm Allen key (max. torque 10 Nm).

*- Make sure the housing gasket is properly placed between the housing parts.*

---

2.11 Re-install the drain and reconnect the outlet hose.

---

2.12 Slowly pressurize the system.

*Your drain is ready for operation!*

2.1

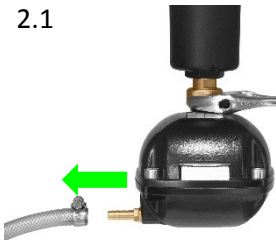

2.2



2.3

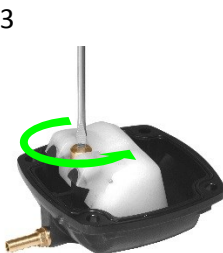

2.4



2.5



2.6



2.7



2.8

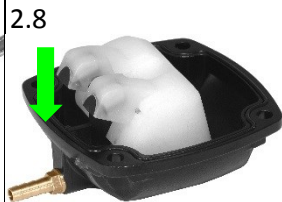

2.9

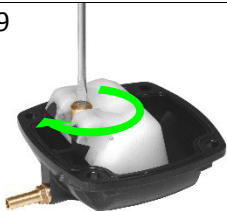

2.10

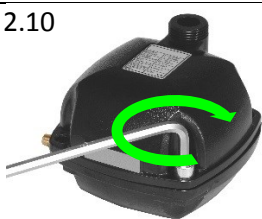

2.11

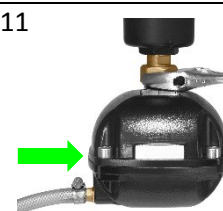

2.12

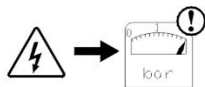

## TECHNICAL SPECIFICATIONS

<b>Max. Filter capacity</b>	Unlimited	
<b>Max. Drainage capacity</b>	200 litres condensate per hour	53 gallons per hour
<b>Pressure range</b>	0 – 16 bar	0 – 230 psi
<b>Valve type</b>	2/2 way, direct acting	
<b>Valve seals</b>	FPM	
<b>Inlet connections</b>	1/2" (BSP or NPT)	
<b>Outlet connection</b>	1/8" BSP	
<b>Inlet height</b>	10 cm	4"
<b>Medium temperature</b>	1 – 50 °C	34 – 122 °F
<b>Ambient temperature</b>	1 – 50 °C	34 – 122 °F
<b>Serviceable valve</b>	Yes	
<b>Housing material</b>	Corrosion resistant aluminium, EP coating	



## ADDITIONAL INSTALLATION INSTRUCTIONS

*Each condensate draining point should have its own drain. Do not use one drain for multiple draining points.*



*Use one drain for each individual draining point.*

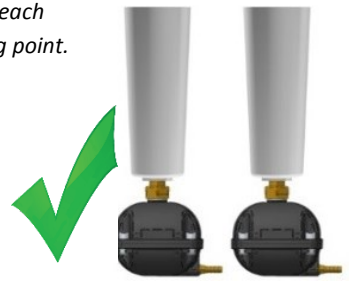

*Avoid water pockets when installing the drain pipe, this will create an air lock.*

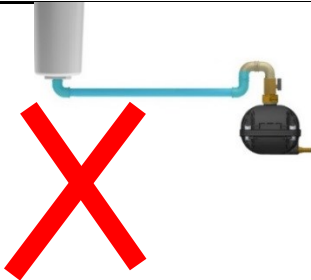

*The ½" drain pipe must be horizontal or ideally at a downwards slope (>1°).*

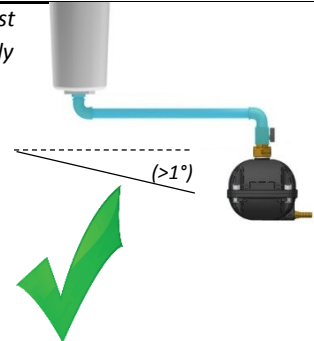

## SERVICE CHART

Date	Description	Name

## DIMENSIONS (mm)

